

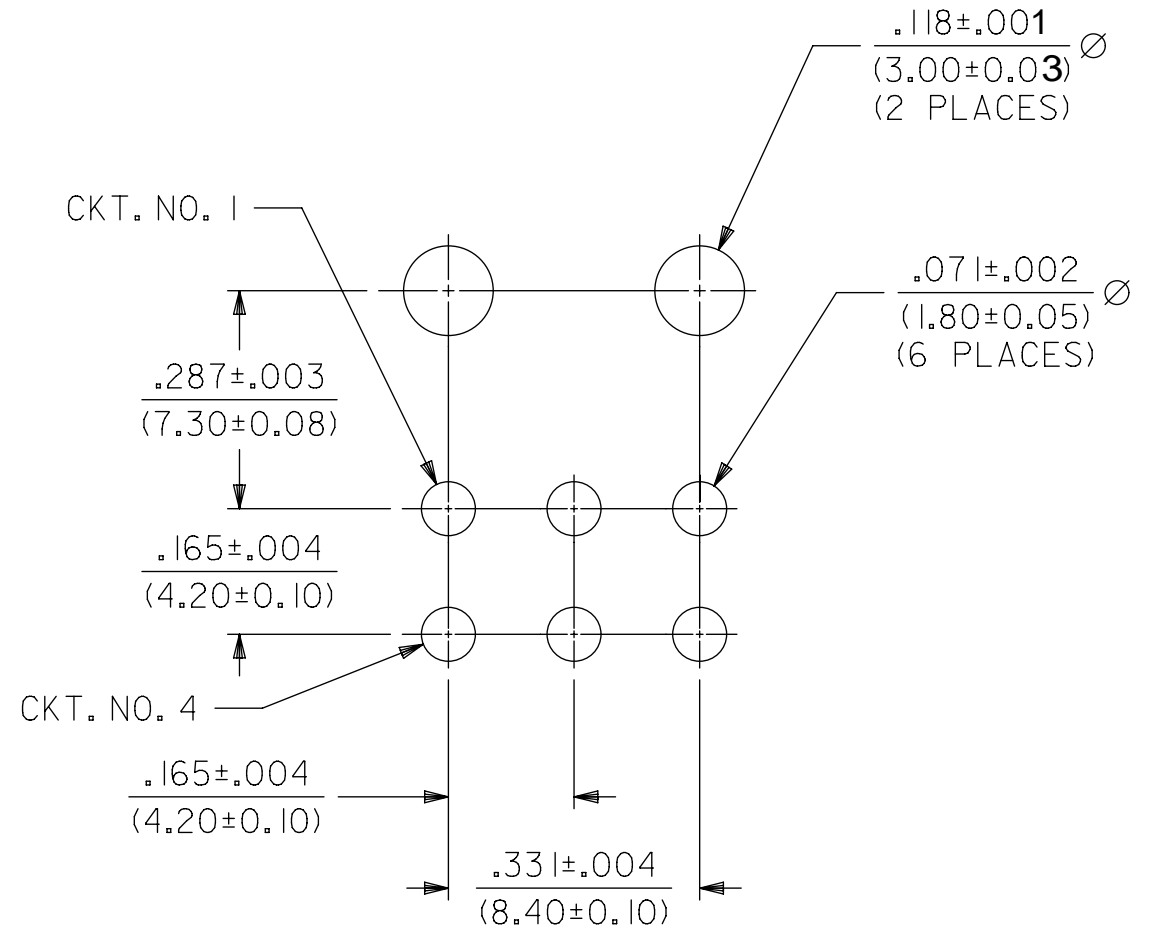

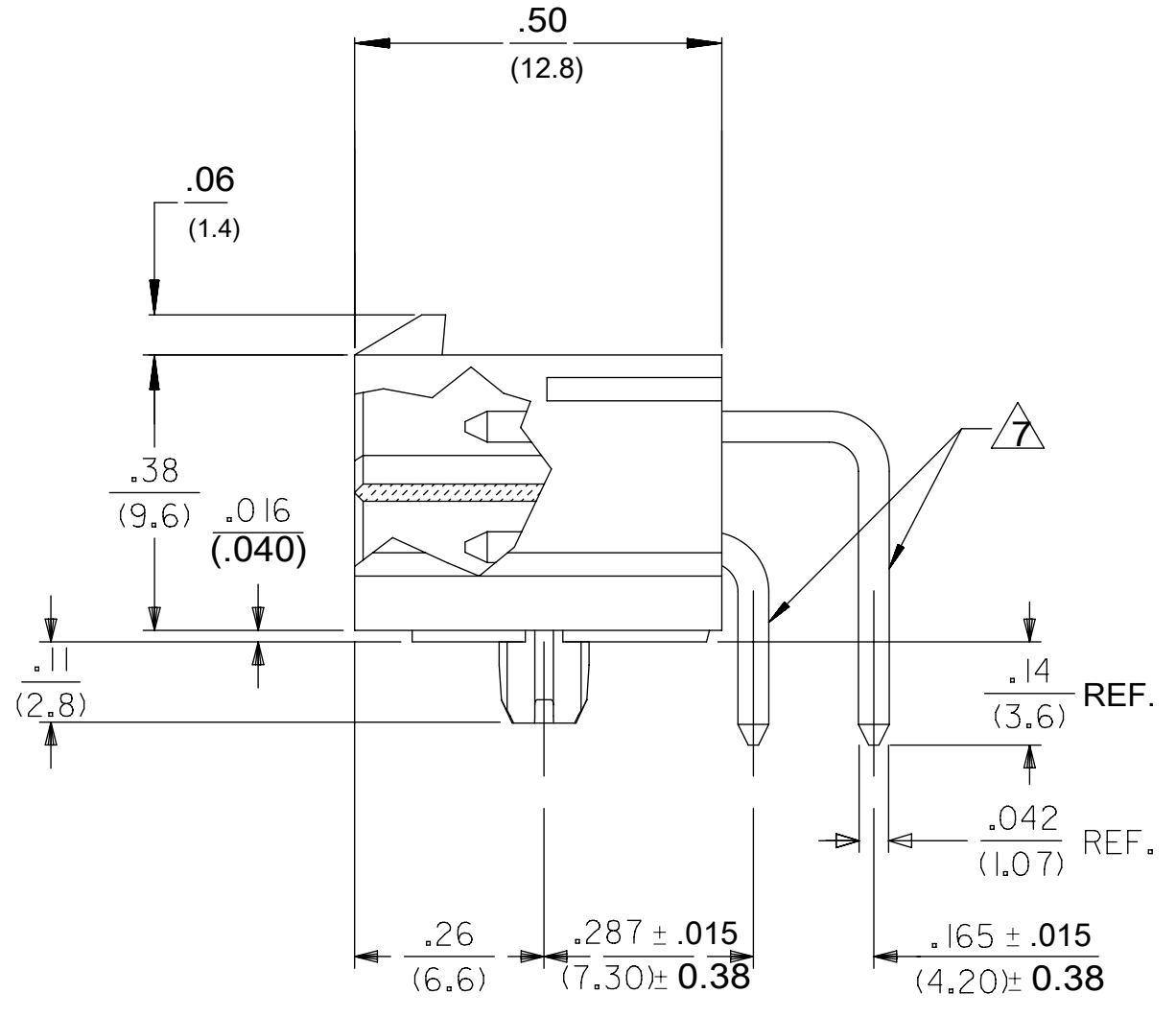

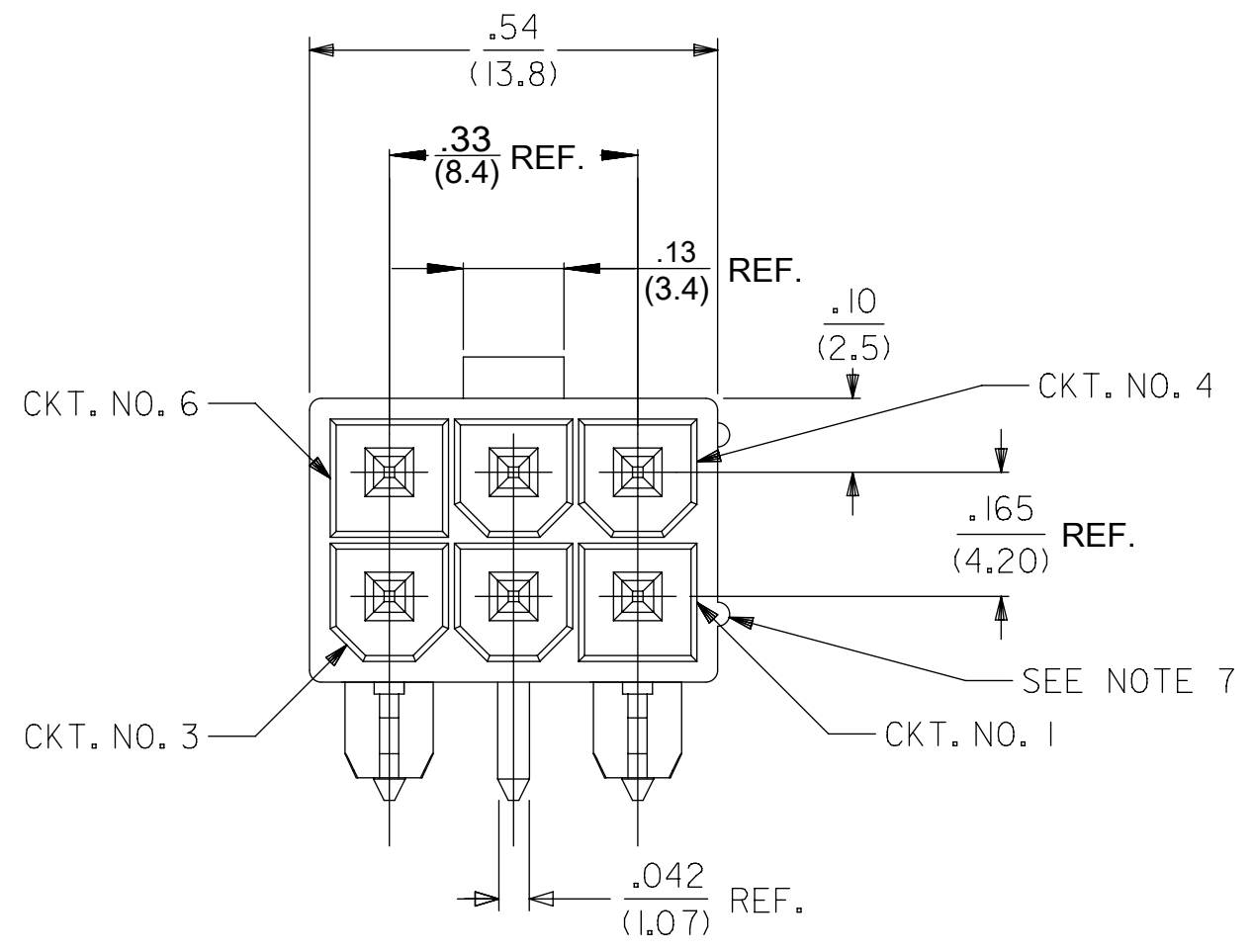

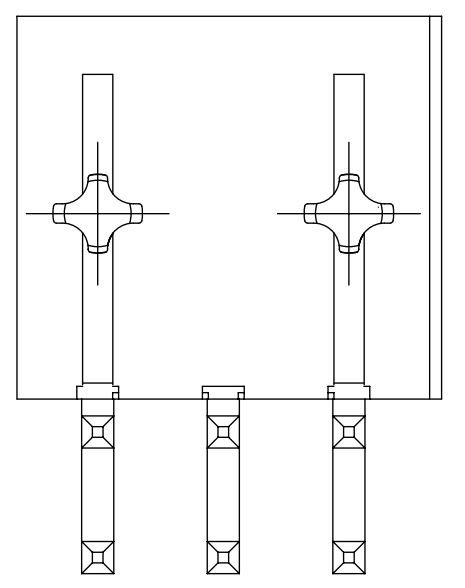



MATERIAL NO.	PACKAGING TYPE 
457320001	BULK
457320003	TRAY
457320004	TAPE & REEL

- NOTES:
- MATERIAL:
HOUSING: LCP, UL94 V-0, COLOR: BLACK
TERMINALS: BRASS
 - TERMINAL FINISH:
.000100/(.00254) MIN. MATTE TIN OVER
.000050/(.00127) MIN. NICKEL OVERALL.
 - PRODUCT SPECIFICATION: PS-45558-001
 - PACKAGING SPECIFICATION:
BULK PER PK-5569-002
TRAY PER PK-5569-003
TAPE & REEL PER RPK-5569-004
 - PARTS MATE WITH MINI-FIT JR. RECEPTACLE 455590002.
 - FULL RIB INDICATES CIRCUIT NO. 1.
 - FORMING MARKS ON PINS ARE ACCEPTABLE
 - PARTS ARE NOT TO BE MATED OR UNMATED WHILE CIRCUITS ARE LIVE.
 - PEGS ARE DESIGNED FOR A PRESS FIT INTO THE P.C. BOARD.
 - PARTS ARE NOT DESIGNED FOR CURRENT SHARING.
 - DISCOLORATION IN THE BANDOLIER CARRIER AREA OF THE PIN IS INHERENT TO THE PLATING PROCESS AND IS DUE TO THE MASKING EFFECT OF THE CARRIER. THIS DISCOLORATION IS IN A NON-FUNCTIONAL AREA OF THE PIN AND WILL NOT AFFECT THE PERFORMANCE OF THE HEADER ASSEMBLY.
 - PART CONFORMS TO CLASS "B" REQUIREMENTS OF COSMETIC SPECIFICATION PS-45499-002.



RECOMMENDED HOLE LAYOUT FOR
.070/(1.78) MAX. THICK P.C. BOARD.
VIEWED FROM COMPONENT SIDE OF BOARD.



SYMBOLS		THIS DRAWING CONTAINS INFORMATION THAT IS PROPRIETARY TO MOLEX ELECTRONIC TECHNOLOGIES, LLC AND SHOULD NOT BE USED WITHOUT WRITTEN PERMISSION			
		DIMENSION UNITS		SCALE	
	= 0	IN/MM		4:1	
	= 0	GENERAL TOLERANCES (UNLESS SPECIFIED)			
	= 0		MM	INCH	
	= 0	4 PLACES	±	±	
	= 0	3 PLACES	±	± 0.01	
	= 0	2 PLACES	± 0.25	± 0.015	
	= 0	1 PLACE	± 0.38	±	
	= 0	0 PLACES	±	±	
	= 0	ANGULAR TOL		± 0.5 °	
	= 0	DRAFT WHERE APPLICABLE MUST REMAIN WITHIN DIMENSIONS		THIRD ANGLE PROJECTION	
		CURRENT REV DESC: ADDED P/N 457320004			
		EC NO: 642890		2020/08/05	
		DRWN: EHAUGERUD		2020/08/07	
		CHK'D: DSTEIER		2020/08/10	
		APPR: FSMITH		2020/08/10	
		INITIAL REVISION:			
		DRWN: GEP		2005/03/12	
		APPR: FSMITH		2012/02/02	
		DRAWING		SERIES	
		C-SIZE		45732	
		DOCUMENT NUMBER		DOC TYPE DOC PART REVISION	
		SD-45732-001		PSD 000 B4	
		MATERIAL NUMBER		CUSTOMER	
		SEE TABLE		GENERAL MARKET	
		SHEET NUMBER		1 OF 1	